

Article number: 58614064

Description: Push-on 140.64, Ø9/12 - G 1/4"
Angle

Measures

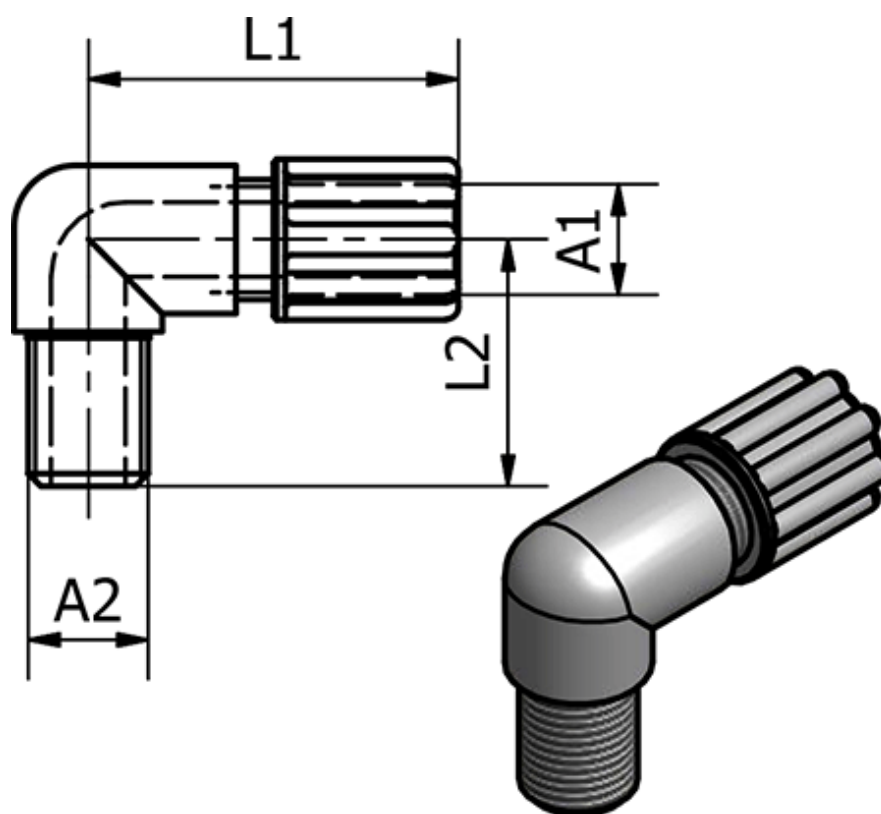

Ext. Hose Diameter A1	= 9/12
L1	= 37
L2	= 32
Thread A2	= G 1/4"